

Interface converter

Communication USB – RS485

K-114

The K-114 interface converter is best used with KELLER products and enables communication between a device and computer via a USB interface.

Description

The interface converter communicates with the connected devices via an RS485 bus. Power is supplied to the connected devices via the computer's USB interface or an external power supply.

Bias or termination resistors may be activated to improve the resistance to interference of communications made via the RS485. An echo function may also be used.

Multimeter/measuring analog signals

The K-114 converter measures the connected end consumers' current consumption levels, as well as an arbitrary voltage signal. These signals can be evaluated and displayed using the software provided. This means that if a single external device is connected, a functional check can be performed on it or the analog pressure signal can be displayed.

The K-114 interface converter enables

- ✓ Communication USB – RS485 (half-duplex)
- ✓ Power supply to connected devices (12 VDC)
- ✓ Measurement of applied signal voltage (0...12 VDC)
- ✓ Measurement of the current consumption of end consumers (0...40 mA)
- ✓ Optical status and configuration display (LED)
- ✓ Galvanic isolation between computer and converter
- ✓ Selective activation of echo function, bias resistors or a termination resistor



Technical specifications

Power supply to end consumer (without power adapter)	12 VDC / max. 40 mA
External power supply (with power adapter)	12...20 VDC / <150 mA
Voltage input	0...12 VDC / Accuracy 0,3 %FS (RI ≥ 30 kΩ)
Resolution of voltage input	<0,016 V
Current measurement	0...40 mA / Accuracy 0,3 %FS
Resolution of current measurement	<0,05 mA
Interface / plug type	USB 2.0 / Mini USB-B
RS485 configuration parameters	ECHO / BIAS (2 x 560 Ω) / Termination (120 Ω)
RS485 transmission rate (slow)	up to 250 kbps
RS485 transmission rate (high)	up to 3 Mbps
RS485 bus devices	up to 128 bus devices (1/4 unit load)
RS485 cable length	0,75 m
Storage / operating temperature	-10...50 °C
H x W x D	56 x 31 x 24 mm
Weight	approx. 90 g
Protection	IP40

Functions

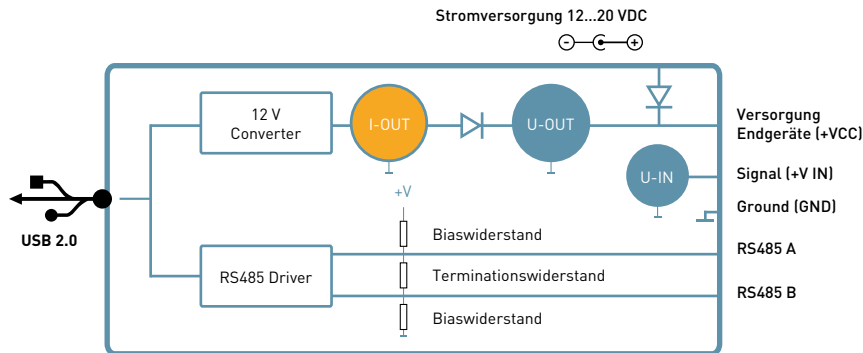

The K-114 converter shows the connection status and selected configuration parameters, which are displayed via status LEDs.

The digital multimeter enables measurement of the supply voltage U-OUT [VDC] and the current consumption of the connected consumers I-OUT [mA], as well as measurement of the voltage signal U-IN [VDC] of the connected device.

The K-114 interface converter generates a virtual COM port via which the RS485 interface can be accessed. The converter can be configured via address 253.

Communication can be established with the connected devices via an RS485 (half-duplex mode) bus at 9600 baud (default) or 115200 baud, 8 data bits, 1 stop bit and no parity.

Power is supplied to the connected devices via the USB interface or an external power supply. KELLER products operate with fail-safe drivers, which output a logical high at the receiver outlet in the event of short-circuited, open or non-terminated inputs in order to avoid invalid signal states. The RS485 drivers are also slew-rate limited, which limits the edge steepness of the driver output and thus suppresses reflections, even when the RS485 interface is not connected.

Software

ControlCenterSeries30

ControlCenterSeries30 makes it easy to record and visualise pressure and temperature data, as well as the power consumption or voltage signal pattern.

- ✓ Visualise measurement data for several devices via RS485
- ✓ Analog output signal for 1 device (4...20 mA or 0...10 V)



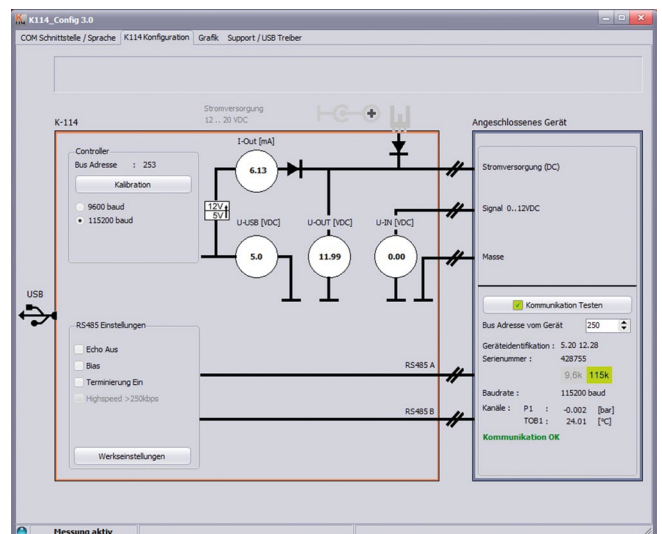
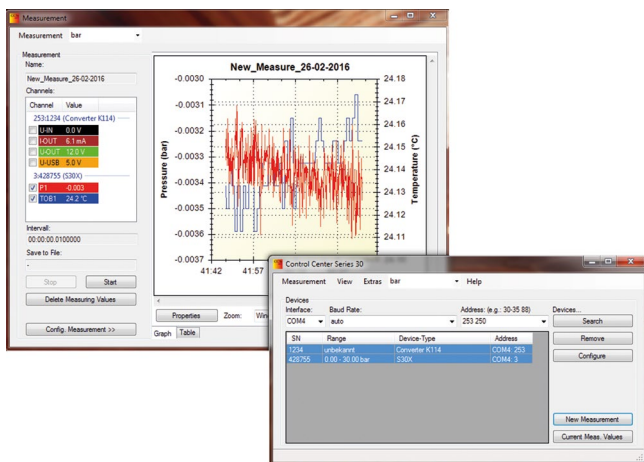

K-114_Config



A configuration and diagnostic tool and the status display for the interface converter simplify usage.

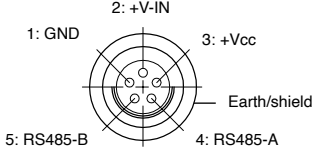
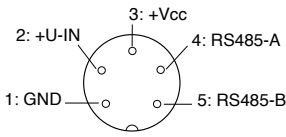

Product overview

The various versions of the K-114 interface converter use different, product-specific interface plugs. The product overview shows the compatibility between the product and the interface converters. The converter can also be expanded using additional cable options. Both the detailed operating instructions and the open-source KELLER software for the interface converter can be found at www.keller-druck.com.

K-114	K-114-A	K-114-B
		
PN: 309010.0074 Application: X-line pressure transmitter with cable gland USB connection: USB cable 1 m (A Mini / B) RS485 connector: 4-pole plug-in screw terminal (MC 1,5 / 5-ST-3.81) Total cable length: 1 m	PN: 309010.0075 Application: DCX-16, DCX-22, DCX-25PVDF, DCX-38, LEO-Record, LEX1, ARC1 LPX, MPX, HPX USB connection: USB cable 1 m (A Mini / B) RS485 connector: Fischer plug-in connector series 103/5-pole (m) Total cable length: 1,75 m	PN: 309010.0076 Application: X-line pressure transmitter with Binder plug-in connector, LEO3 USB connection: USB cable 1 m (A Mini / B) RS485 connector: Binder plug series 581/5-pole (f) Total cable length: 1,75 m
		

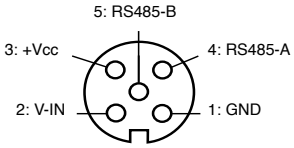

K-114-M	K-114-V												
													
PN: 309010.0149 Application: X-line pressure transmitter with M12 plug USB connection: USB cable 1 m (A Mini / B) RS485 connector: M12 plug A-coded/5-pole (f) Total cable length: 1,75 m	PN: 309010.0132 Application: X-line pressure transmitter manufactured specifically for the customer USB connection: USB cable 1 m (A Mini / B) RS485 connector: With open cable ends Total cable length: 1,70 m												
	<table border="1"> <tr> <td>WH:</td> <td>GND</td> </tr> <tr> <td>GN:</td> <td>+V-IN</td> </tr> <tr> <td>YE:</td> <td>+Vcc</td> </tr> <tr> <td>BN:</td> <td>RS485-A</td> </tr> <tr> <td>GY:</td> <td>RS485-B</td> </tr> <tr> <td>Shield:</td> <td>Earth/shield</td> </tr> </table>	WH:	GND	GN:	+V-IN	YE:	+Vcc	BN:	RS485-A	GY:	RS485-B	Shield:	Earth/shield
WH:	GND												
GN:	+V-IN												
YE:	+Vcc												
BN:	RS485-A												
GY:	RS485-B												
Shield:	Earth/shield												

Scope of delivery

- Manual K-114
- Converter K-114
(per product no. 309010.0XXX)
- USB cable 1 m (A Mini / B)

Accessories

Various adapter cables:

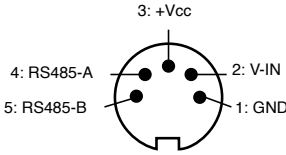
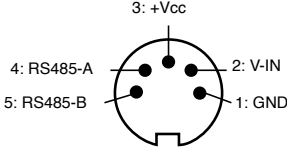
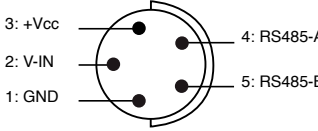
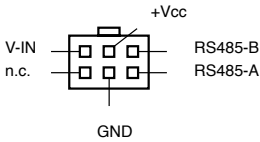
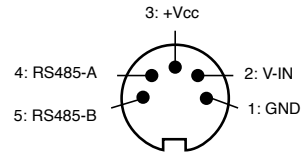
Cable option 1 for K-114-B	Cable option 3 for K-114-B	Cable option 7 for K-114-B															
 <p style="text-align: center;">m</p>	 <p style="text-align: center;">f m</p>	 <p style="text-align: center;">m m</p>															
<p>PN: 309010.0014 Suitable for X-line pressure transmitter with cable gland Cable length: 0,4 m</p>	<p>PN: 309010.0016 Suitable for X-line pressure transmitter, LEO1, LEO2, ECO2 Cable length: 0,4 m</p>	<p>PN: 309010.0082 Suitable for DCX, LEO-Record, LEX1 Cable length: 0,4 m</p>															
<p>Binder plug-in connector series 680/5-pole (m)</p>	<p>Binder plug-in connector series 680/5-pole (m)</p>	<p>Fischer plug-in connector series 103/5-pole (m)</p>															
																	
<p>Licensed connection terminals</p>	<p>Molex plug 6-pole (f)</p>	<p>Binder plug-in connector series 680/5-pole (m)</p>															
<table border="1"> <tr> <td>black</td> <td>BK</td> <td>+Vcc</td> </tr> <tr> <td>white</td> <td>WH</td> <td>GND</td> </tr> <tr> <td>yellow</td> <td>YE</td> <td>RS485-B</td> </tr> <tr> <td>blue</td> <td>BU</td> <td>RS485-A</td> </tr> <tr> <td>red</td> <td>RD</td> <td>V-IN</td> </tr> </table>	black	BK	+Vcc	white	WH	GND	yellow	YE	RS485-B	blue	BU	RS485-A	red	RD	V-IN		
black	BK	+Vcc															
white	WH	GND															
yellow	YE	RS485-B															
blue	BU	RS485-A															
red	RD	V-IN															

Accessories

Various adapter cables:

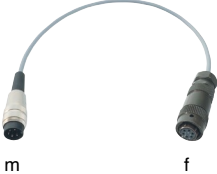
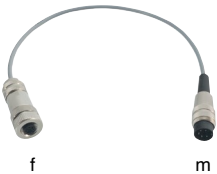
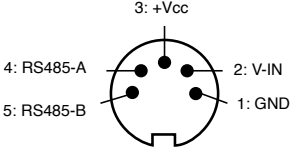
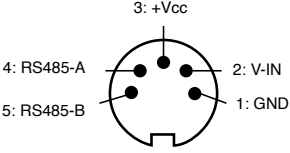
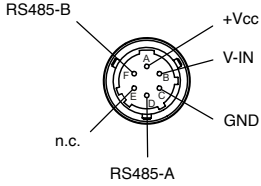
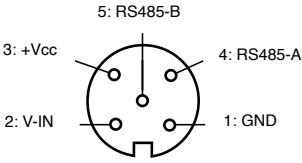
<p>Cable option 8 for K-114-B</p>	<p>Cable option 9 for K-114-B</p>
	
<p>PN: 309010.0123 Suitable for X-line pressure transmitters with Souriau plug Cable length: 0,4 m</p>	<p>PN: 309010.0127 Suitable for X-line pressure transmitters with M12-plug Cable length: 0,4 m</p>
<p>Binder plug-in connector series 680/5-pole (m)</p>	<p>Binder plug-in connector series 680/5-pole (m)</p>
	
<p>MIL plug series C-26482/6-pole (f)</p>	<p>M12 plug A-coded/5-pole (f)</p>
	

<p>Plug power supply 15 VDC for K-114 / K-114-A / K-114-B</p>

<p>PN: 309010.0144 Incl. adapter PLUG-EU, PLUG-GB, PLUG-US/JP Input: 100...240 VAC / 50...60 Hz Output: 15 VDC / 500 mA Cable length: 1,8 m</p>